

Data Sheet



Article number: 03441160

Description: Fluro Rod end GE 160EC-2RS

Measures

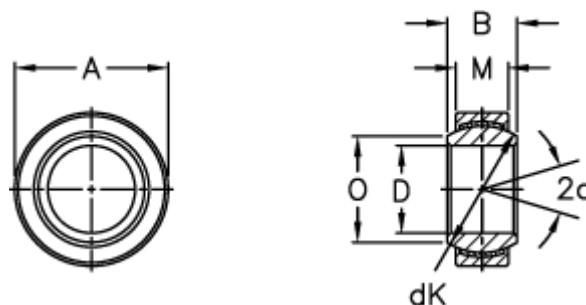

A = 230 0 -0,030

B = 105

D = 160 0 -0,025

dK = 200

Dynamic load C (kN) = 2560

M = 80

O = 170.2

Static load C0 (kN) = 5120

Tilt angle = 8

Weight = 13500